

THE **TTP-SERIES** TRACK LINK PIN PUSHER & INSTALLER IS SPECIALLY DESIGNED FOR TRACKED MACHINES, TRACTORS, LOADERS, SHOVELS, EXCAVATORS, ETC. IT IS SUITABLE TO USE WITH MOST MODERN MACHINES INCLUDING JCB, CATERPILLAR, KOMATSU AND POCLAIN MANUFACTURED TRACK MACHINES.

This portable track pin press makes it possible to disassemble and reassemble chain sections, driving wheels, pulleys, rollers, gears, bearings and shafts in the field or workshop. Every Track Pin Press includes standard tooling sets, the 700 bar cylinder, C-Frame, safety guards and lifting eyebolts, 20 T x 12 mm stroke flat jack, set of hand tools, cylinder seal kit, chain lever hoist, and lifting slings. The chain lever hoist and lifting slings are used to assist in the positioning of the Pin Press during operation in the field. Included is a wooden carry case with separate compartments for every pin set. Each tooling set has the dimensions engraved on them accordingly.



Model No.	Capacity (ton)	Stroke (mm)	Pressure Rating (bar)	Effective Area (cm ²)	Oil Capacity (cc)	A Daylight Opening (mm)	B Throat Depth (mm)	C Assembly Length (mm)	D Assembly Height (mm)	E Assembly Width (mm)	No. Tooling Sets	Approx. Weight (kg)*
TTP-50	50	250	700	70.88	1,772	273	65	1,400	320	270	4	85
TTP-100	100	350	700	132.70	4,645	345	85	1,750	435	305	10	205
TTP-150	150	350	700	213.80	7,484	420	100	2,103	533	410	8	372
TTP-200	200	350	700	283.50	9,923	455	110	2,245	598	460	10	630

*Frame & Cylinder Assembly



CAPACITY
50 - 200 ton

STROKE
250 - 350 mm

MAXIMUM OPERATING PRESSURE
700 bar

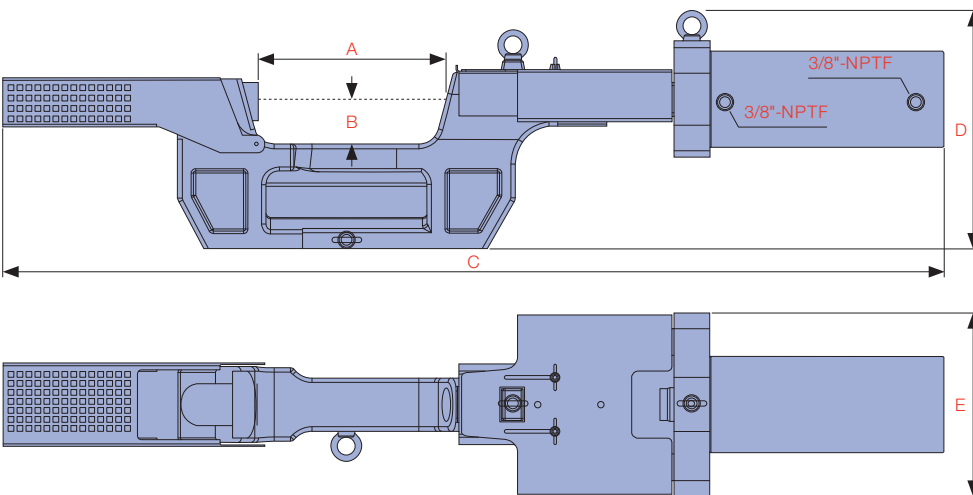

TYPICAL TOOLING SET

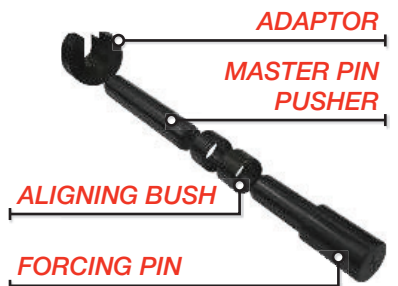

STANDARD INCLUDED TOOLING SETS

TTP-50	TTP-100	TTP-150	TTP-200
Track Pin Diameter (mm)	Track Pin Diameter (mm)	Track Pin Diameter (mm)	Track Pin Diameter (mm)
19.3 - 23.7	19.3 - 23.7	22.0 - 30.1	36.4 - 39.6
23.7 - 30.1	23.7 - 30.1	30.1 - 33.4	39.6 - 42.8
30.1 - 33.2	30.1 - 33.2	33.4 - 38.1	42.8 - 45.9
33.2 - 36.4	33.2 - 36.4	38.1 - 41.9	45.9 - 52.3
	36.4 - 39.6	41.9 - 45.7	52.3 - 58.6
	39.6 - 42.8	45.7 - 50.8	58.6 - 60.2
	42.8 - 45.9	50.8 - 53.8	60.2 - 63.3
	45.9 - 52.3	53.8 - 57.1	63.3 - 66.6
	52.3 - 58.6	57.1 - 60.3	66.6 - 70.0
	58.6 - 60.2	60.3 - 63.3	70.0 - 73.9
		63.3 - 66.6	
		66.6 - 70.0	

**Optional tooling set TTP-150 small pin group

Did you know...







The optional small pin group set allows the TTP-150 unit to be used on smaller diameter pins. Ordering code: TTP-150 #1-#4-SMALL PIN GROUP

TRACK PIN PUSHERS

B

TRACK PIN PUSHERS

PUMP SELECTION CHART



Pump / Power Unit Model No.	Description	TTP-50	TTP-100	TTP-150	TTP-200
 P-2800D	Hand Pump	✓	✓		
 SPEM45054L	230V/50/1* Electric Pump with Gauge & Remote Pendant (Standard Supply)	✓	✓		
 PEM8414	230V/50/1* Electric Pump with Gauge & Remote Pendant (Standard Supply)			✓	
 PEM8424	230V/50/1* Electric Pump with Gauge & Remote Pendant (Standard Supply) 20 Litre Oil Tank				✓
 DPA-40D	Air Hydraulic Pump	✓			
 DPR-174	Air Hydraulic Pump	✓	✓	✓	✓
 PPM2014	Petrol Pump	✓	✓	✓	✓

*115 Volt versions available

Did you know...

Durapac 700 bar power units are compatible with a wide range of hydraulic tools such as jacking cylinders, bearing separators and other hydraulic maintenance tools.

i

Accessory Model No.	Description	TTP-50	TTP-100	TTP-150	TTP-200
 HPS-0603CR	3 Mtr Red Hose with CH-6 Male Coupling one end and 3/8"-NPT Male thread at other end. (2 required, 2 x HPS-0603CR should be ordered)	✓	✓	✓	✓
 HPS-0606CR	6 Mtr Red Hose with CH-6 Male Coupling one end and 3/8"-NPT Male thread at other end. (2 required, 2 x HPS-0606CR should be ordered)	✓	✓	✓	✓
 FGA-18 + PG-63**	Gauge Adapter (3/8"-NPT male x 3/8"-NPT female x 1/4"-NPT female) plus Pressure Gauge (63 mm diam. 0-1,000 bar / 0-14,500 psi 1/4"-NPT male)	✓	✓	✓	✓

**Option not required when using PEM8414, PEM8424 or SPEM4505L - these models come standard with Pressure Gauges



TTP-100 COMPLETE KIT